

TELESCOPING SLIDING GATE SYSTEM

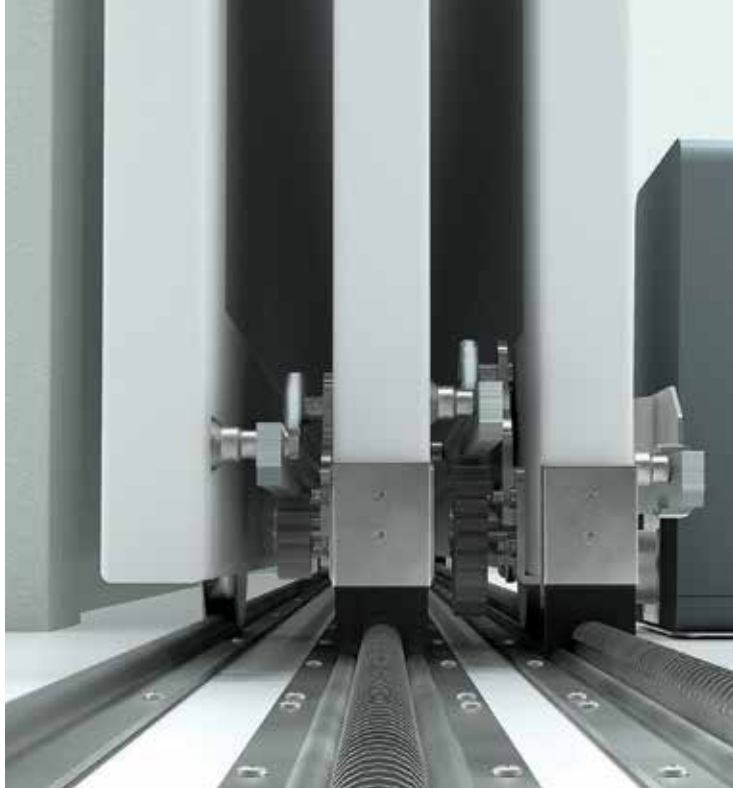

Ranger

The Comunello telescoping gate system.

- Up to 40ft opening requiring only 15ft of space to slide into
- Low maintenance
- Maintains precision
- No unsightly cables

Manufactured by
 **COMUNELLO**
LIFE MADE EASY



Watch a video for more information.

The Ranger telescoping system uses an innovative ground mounted rack track to drive a second leaf from the first. This track transmits movement using a system of hidden pinions that connect to the side gear rack, driving the next leaf. The simplicity of the Ranger system ensures that it is easy to install, performs reliably, and requires little maintenance. No cables are used so there is no stretching and no regular adjustments are needed. The rack track is brushed clean on every opening by the two cleaning brushes installed on the front and back of each gate leaf.



AIDI
ARCHITECTURAL
IRON DESIGNS, INC.

950 South 2nd Street, Plainfield, NJ 07063 | Ph: (800) 784-7444 or (908) 757-2323
Fax: (908) 757-3439 | www.locks4gates.com | sales@locks4gates.com

RANGER TELESCOPING SLIDING GATE SYSTEM

Ranger features:

- 2 leaf telescoping system
—Max Gate Leaf 14'4" and 880 lbs.
- 3 leaf telescoping system
—Max Gate Leaf of 14'7" and 440 lbs.
- Durable galvanized and zinc coated steel hardware
- Large gate opening possible for compact spaces
- Precise, high quality, ground-mounted rack driven track system
- Cableless rack and pinion transmission of movement between the leaves

The **RG-10 template guide** sets the spacing between the gate panels at 2-3/8" (60mm) for proper spacing alignment for the top guide wheels and drive rack and pinion combination. Set the template guide to 50 for 2" gate profiles as shown.

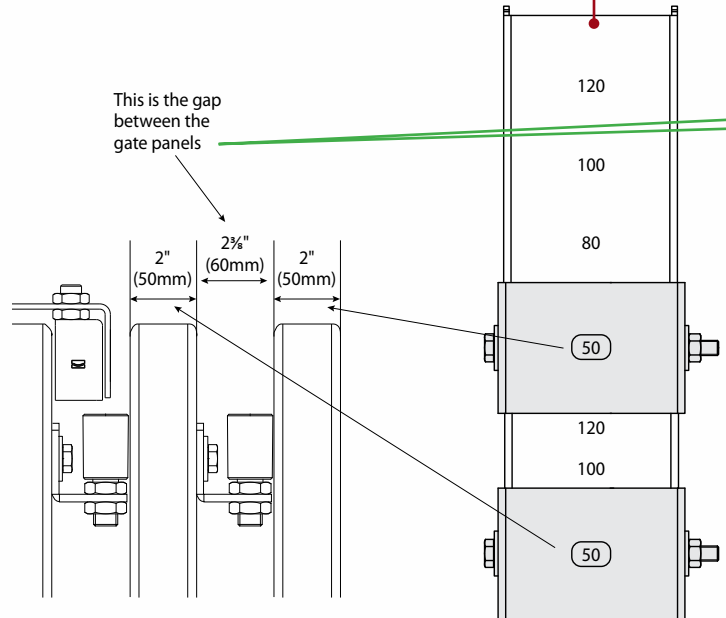

CG-15M
Adjustable
mounting bracket



CG-30M
Gate receiver

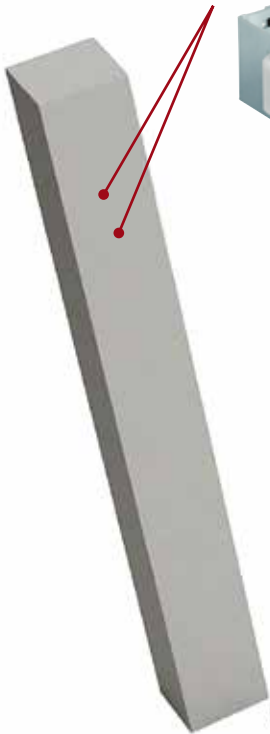

289
Galvanized half round track



RANGER TELESCOPING SLIDING GATE SYSTEM

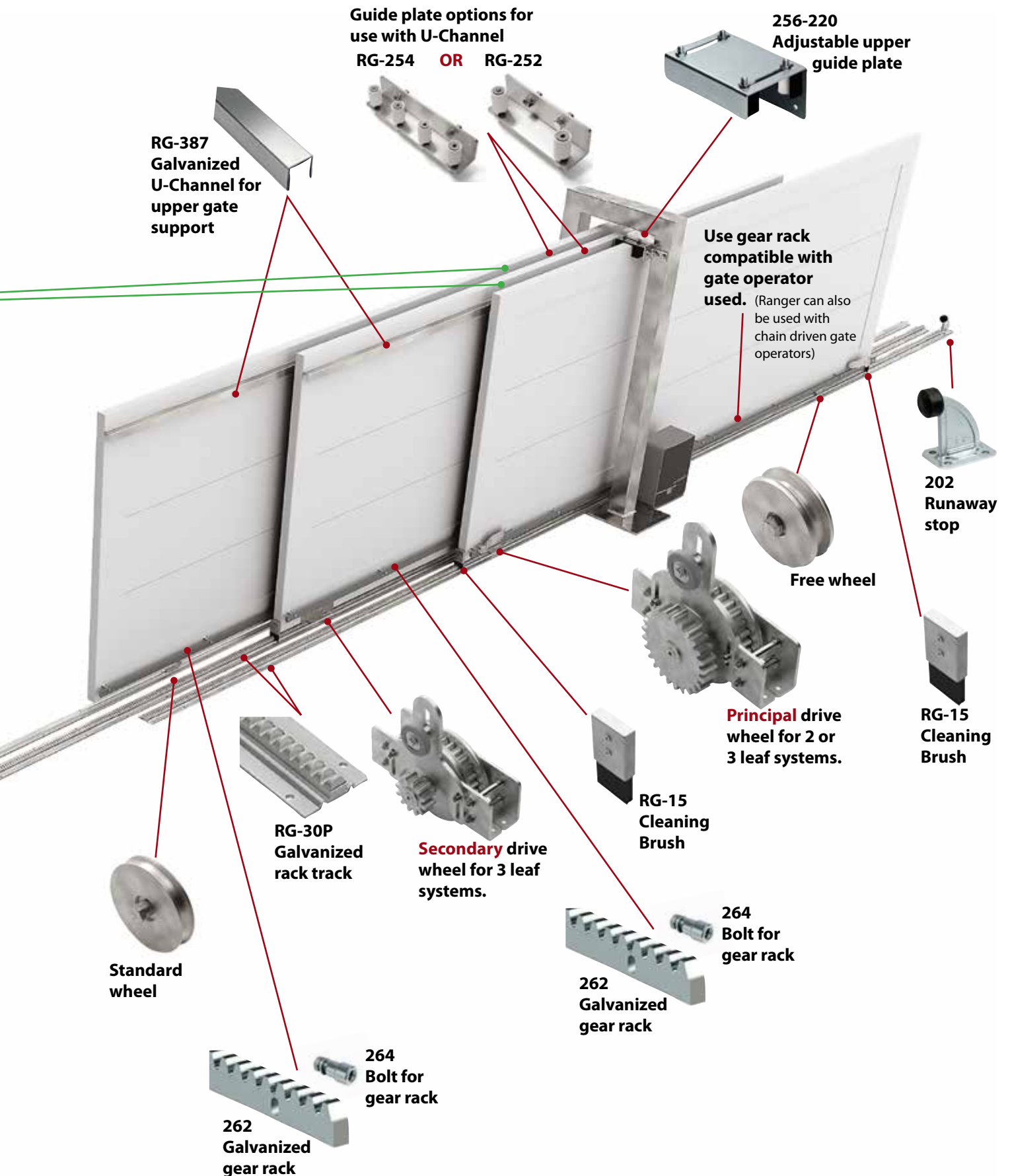

RANGER TELESCOPING SLIDING GATE 2 LEAF KIT

Ranger Kit RG2-120-50

Configurator for
2 leaf gates

- Fits **2" x 4"** frame
- 880 pounds per leaf maximum
- 26ft maximum opening

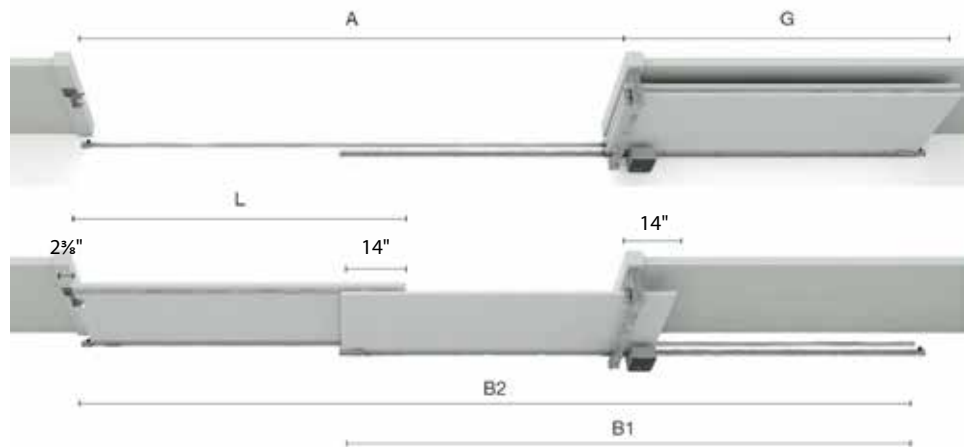

GATE FORMULAS

Gate Leaf Length
 $L \text{ (in)} = (A + 2.5) \div 2 + 14$

Min Space when Open
 $G \text{ (in)} = L + 8$





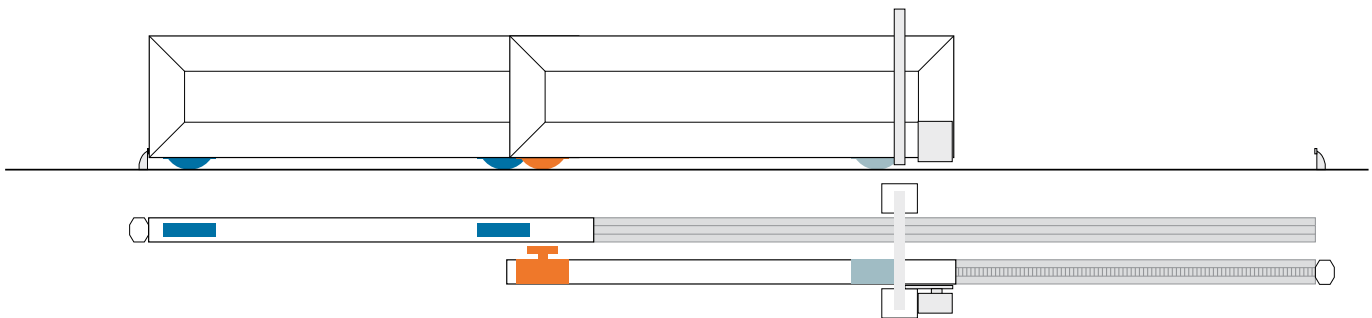

Rack Drive Track Length
 $B1 \text{ (in)} = L \times 2 - 14$

Half Round Track Length
 $B2 \text{ (in)} = L \times 3 - 28$

Note: The parameters in **BOLD** in the formulas above are inches.

Opening Width A (ft)	Gate Leaf Length L (ft)	Minimum Clear Space on Open Side G (ft)	Rack Track Length Item RG-30 B1 (ft)	Half Round Track Length Item 289 B2 (ft)
6	4'4"	5'	7'6"	10'8"
8	5'4"	6'	9'6"	13'9"
10	6'4"	7'	11'6"	16'9"
12	7'4"	8'	13'6"	19'9"
14	8'4"	9'	15'6"	22'9"
16	9'4"	10'	17'6"	25'9"
18	10'4"	11'	19'6"	28'9"
20	11'4"	12'	21'6"	31'9"
22	12'4"	13'	23'6"	34'9"
24	13'4"	14'	25'6"	37'9"
26	14'4"	15'	27'6"	40'9"



2 LEAF KIT		Opening Range: 26ft max • Weight: 880lbs per leaf max	
WHEELS	  	RG2-120-50 1 drive wheel 1 free wheel 2 standard wheels with half-round groove	
TRACK	RG-30P Galvanized Rack Track 6'6" sections <i>Use table above to calculate track needed by using (B1)</i>	 289-19.68FT 289-9.84FT Galvanized Half Round Track <i>Use table above to calculate track needed by using (B2)</i>	
RACK	 262 Galvanized Gear Rack 3'3" sections	 266 Gear rack connection to screw rack to gate	 264 Gear rack connection to weld rack to steel gate (3 connectors are needed per 3'3" section of gear rack)

RANGER TELESCOPING SLIDING GATE 3 LEAF KIT

Ranger Kit RG3-120-50

Configurator for
3 leaf gates

- Fits 2" x 4" frame
- 440 pounds per leaf maximum
- 40ft maximum opening

GATE FORMULAS

Gate Leaf Length
L (in) = (A + **2.5**) ÷ 3 + **14**

Min Space when Open
G (in) = L + **8**

Rack Drive Track Length
B1 (in) = L x 2 - **14**

Rack Drive Track Length
B2 (in) = L x 3 - **28**





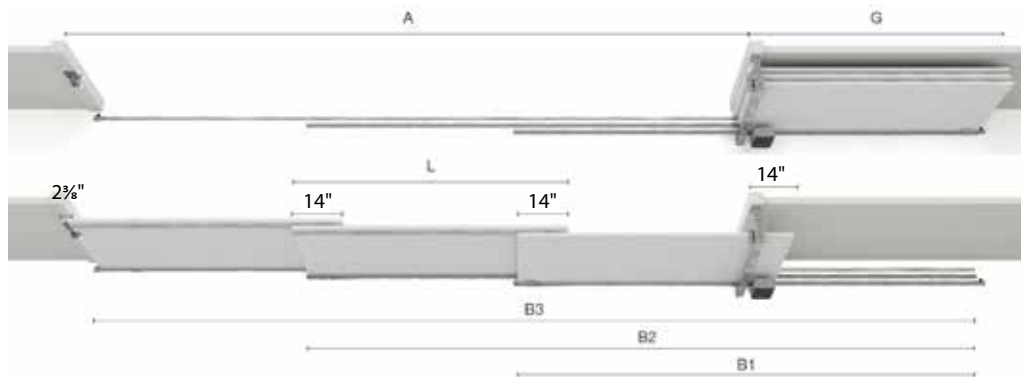

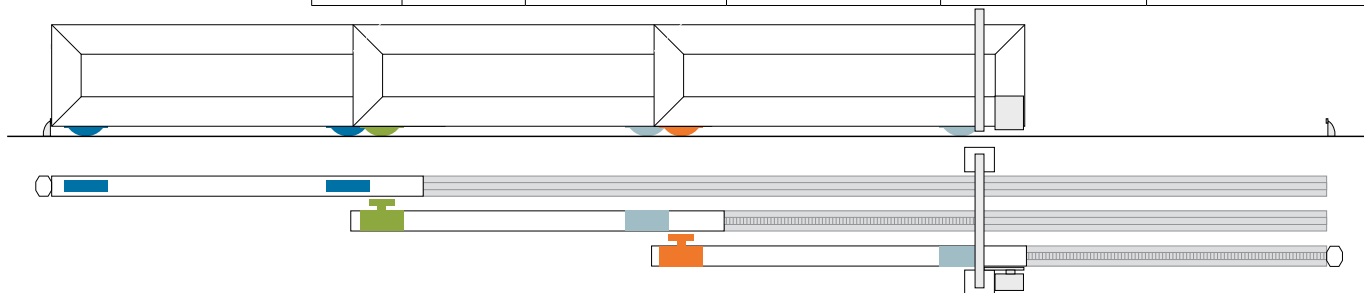

Half Round Track Length
B3 (in) = L x 4 - **39**

Note: The parameters in **BOLD** in the formulas above are inches.



Opening Width A (ft)	Gate Leaf Length L (ft)	Minimum Clear Space on Open Side G (ft)	Rack Track Length Item RG-30 B1 (ft)	Rack Track Length Item RG-30 B2 (ft)	Half Round Track Length Item 289 B3 (ft)
6	3'3"	3'11"	5'4"	7'5"	9'9"
8	3'11"	4'7"	6'8"	9'5"	12'5"
10	4'7"	5'3"	8'	11'5"	15'1"
12	5'3"	5'11"	9'4"	13'5"	17'9"
14	5'11"	6'7"	10'8"	15'5"	20'5"
16	6'7"	7'3"	12'	17'5"	23'1"
18	7'3"	7'11"	13'4"	19'5"	25'9"
20	7'11"	8'7"	14'8"	21'5"	28'5"
22	8'7"	9'3"	16'	23'5"	31'1"
24	9'3"	9'11"	17'4"	25'5"	33'9"
26	9'11"	10'7"	18'8"	27'5"	36'5"
28	10'7"	11'3"	20'	29'5"	39'1"
30	11'3"	11'11"	21'4"	31'5"	41'9"
32	11'11"	12'7"	22'8"	33'5"	44'5"
34	12'7"	13'3"	24'	35'5"	47'1"
36	13'3"	13'11"	25'4"	37'5"	49'9"
38	13'11"	14'7"	26'8"	39'5"	52'5"
40	14'7"	15'3"	28'	41'5"	55'1"



3 LEAF KIT		Opening Range: 40ft max • Weight: 440lbs per leaf max		
WHEELS	   	RG3-120-50	1 drive wheel 1 drive wheel with low gear ratio 2 free wheels 2 standard wheels with half-round groove	
TRACK		RG-30P Galvanized Rack Track 6'6" sections <i>Use table above to calculate track needed by adding (B1) and (B2)</i>		289-19.68FT / 289-9.84FT Galvanized Half Round Track <i>Use table above to calculate track needed by using (B3)</i>
RACK		262 Galvanized Gear Rack 3'3" sections		266 Gear rack connection to screw rack to gate
				264 Gear rack connection to weld rack to steel gate <i>(3 connectors are needed per 3'3" section of gear rack)</i>

RANGER TELESCOPING SLIDING GATE ACCESSORIES

KIT COMPONENTS

Principal drive wheel for 2 or 3 leaf systems

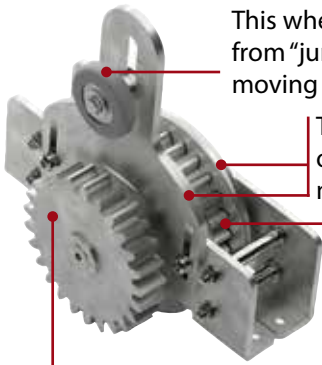

This wheel helps to keep the drive pinion from "jumping" out of the rack rail when moving down the track.

The wheel sits on two external profiles of the rack track for a smoother movement.

Wheel unit is made up of a principal pinion drive wheel, that when rolling on the rack track, generates the rotation of the external secondary pinion.

The movement via the second external pinion is transmitted to the rack mounted onto the side of the second gate leaf.

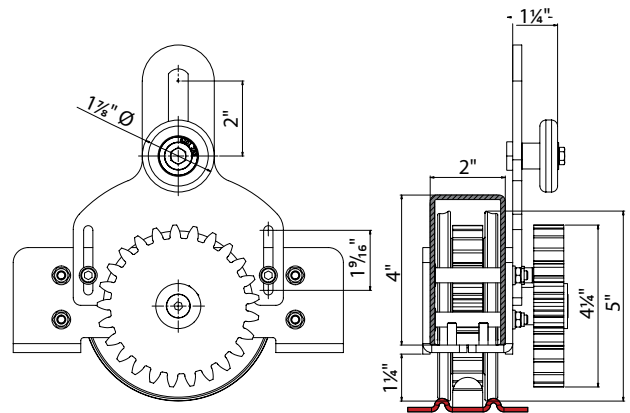

Free wheel

The wheel rides on two external profiles of the track for so the gears in the track and pinion do not bind for a smoother movement.

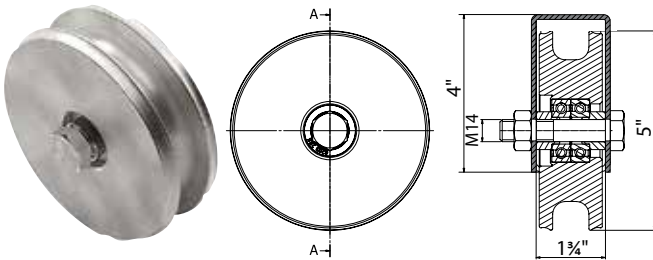

RG-30P

Galvanized rack track 6'6" sections

Movement is generated by the ground mounted rack that also functions as a track.

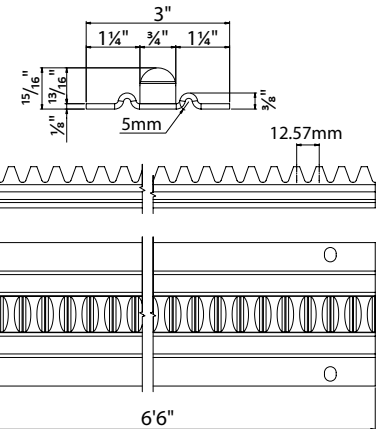

The rack track is equipped with two side guides on which the drive and free wheel sits. This is to ensure that the weight of the gate is not loaded on the rack and/or pinion teeth.

Standard wheel with half round groove

The wheel rides on the half round track.

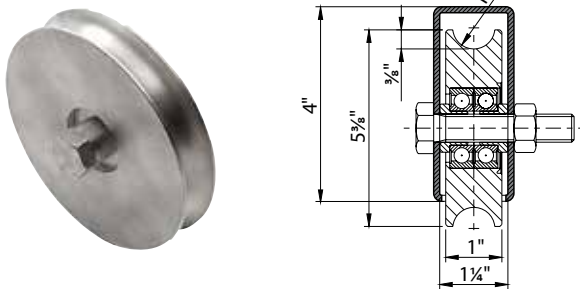

289-19.68FT

289-9.84FT

Galvanized half round track

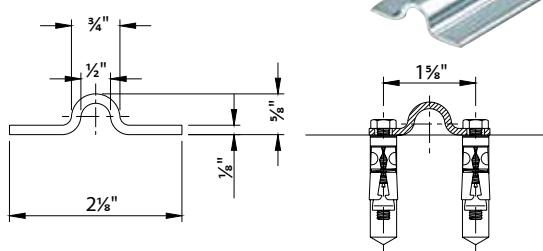

Secondary drive wheel for 3 leaf systems.

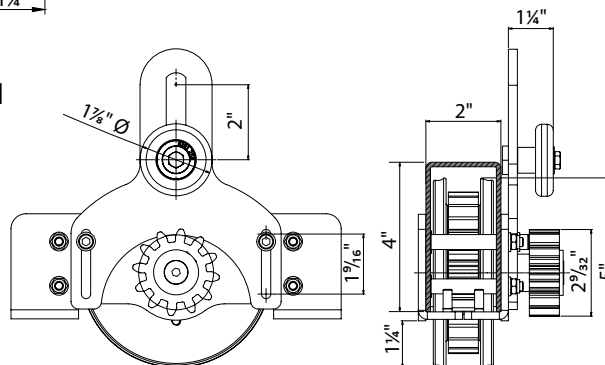

RANGER TELESCOPING SLIDING GATE ACCESSORIES

UPPER GUIDES FOR 1ST LEAF

255-220 - For 1 1/4" - 2 3/8" frames

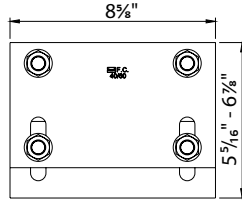
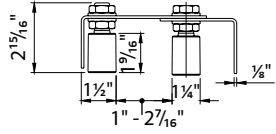

256-220

For up to - 3 1/8" frames

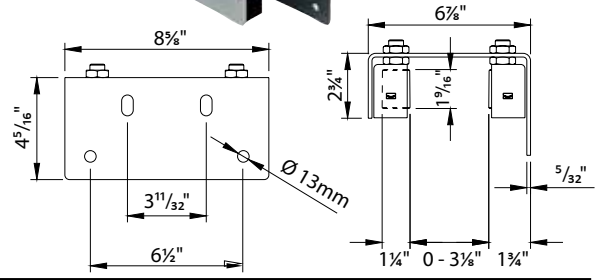

UPPER GUIDES FOR 2ND & 3RD LEAVES

RG-387-19.68FT

RG-387-9.84FT

Galvanized
U-Channel for upper
gate support

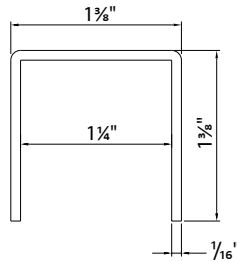

RG-252

Guide plate
for use with
U-Channel

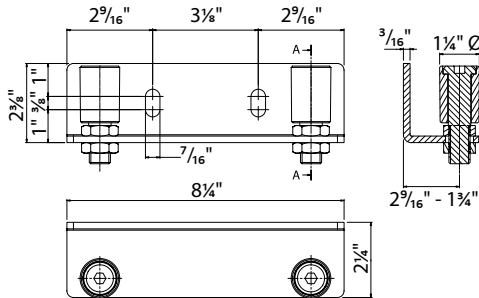

RG-254
Guide plate
for use with
U-Channel



*Comunello recommends this
guide for added stability
with changing wind
speeds and smoother
rolling gates.*

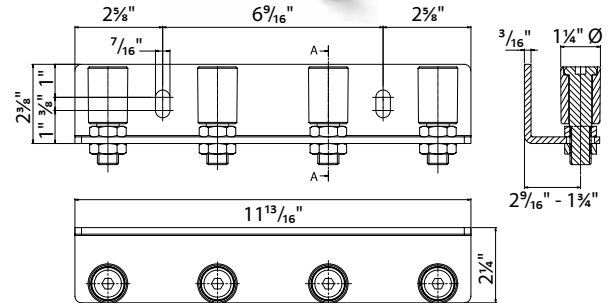

BRACKETS



CG-15M

Adjustable
mounting bracket



CG-30M

Gate receiver,
2" - 3" frame



Top cup gate receiver
w/shock absorber

199-50 - 2" ID
199-60 - 2 3/8" ID

GATE STOPS



202

Runaway stop
Mounted via screws



202F-A

Damped runaway
stop. Mounted via
screws.



CG-58

Drive Shaft Coupling. Use when
connecting a gate operator to the
principal drive wheel.

ADAPTER

GATE AUTOMATION SPEED REDUCTION



RG-40

Ranger speed
reduction system

The RG-40 speed reducer cuts the speed of the first panel by 50%, to reduce the speed of 2 or 3 leaf Ranger telescoping gates. The gear box is mounted to the pad and connected directly to the rack on the first leaf. The motor is then coupled using the CG-58 adapter, directly to the speed reduction system drive shaft. Telescoping systems move twice or three times the speed of single gates, so reducing the speed of the leading edge is critical for safety.



CG-45

Electromechanical limit switch

The CG-45 switches replace the limit switches that come with the gate operator. As the gate operator is moved back from the gate by several inches to fit the RG-40, the typical limit switches may not attach or work easily.

Specs:

- NC Normally Closed contact
- IP 67 Rated Enclosure
- 12/24V DC



RANGER TELESCOPING SLIDING GATE TEMPLATES

Templates are purchased once and can be reused for subsequent installations.

RG-10 2 template guide kit for Rack Track installation

These alignment guide tools ensure a rapid and precise installation of the rack tracks that make up the 2 and 3 leaf telescoping systems. The smooth half round track (#289) is installed first, and is used as the reference for the proper parallel placement and alignment of the rack tracks. The two alignment guide tools are used to maintain the correct spacing between the tracks, according to the gate frame width value selected on the tools. These guides also ensure that the rack teeth are aligned and in sync when connecting additional rack track sections together.

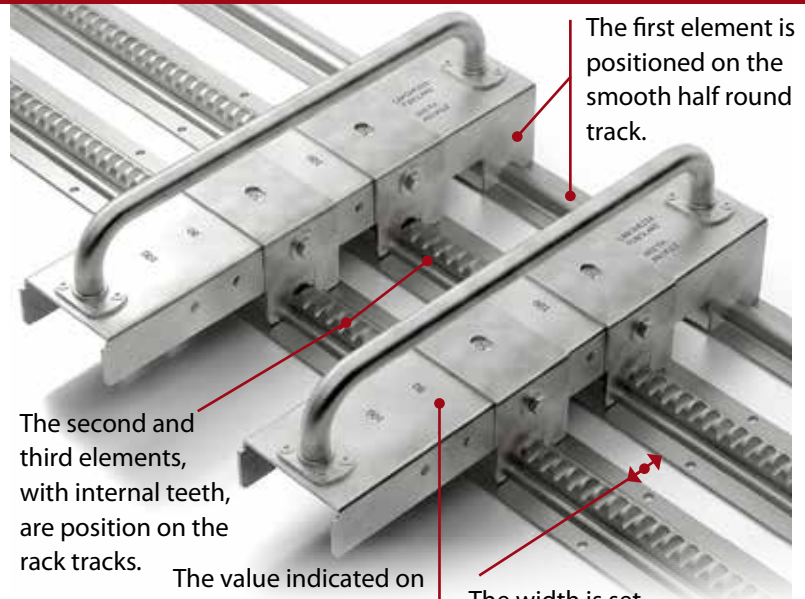

The second and third elements, with internal teeth, are positioned on the rack tracks.

The value indicated on the template indicates the size of the gate frame. Use the setting "50" for 2" wide profiles.

The width is set according to the gate frame size used to construct the gate.

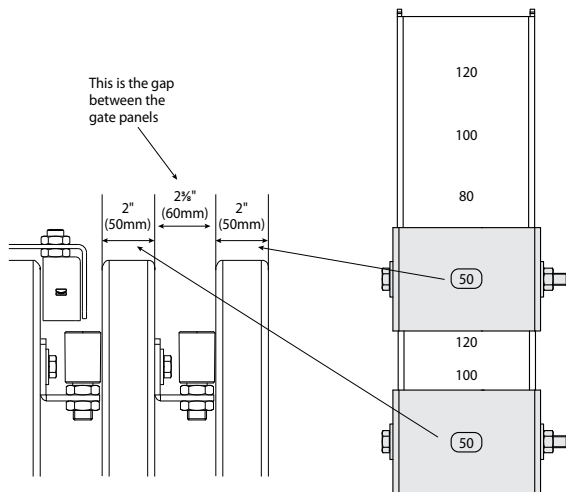

The rack track installation templates are used to ensure a precise and parallel alignment of the ground tracks, and can be width-regulated depending on the profile width of the gate frame tubing used in the construction of the gate. When joining two pieces of rack track, the precise position for the teeth can be achieved using the toothed element of the template guide, positioning it directly on the joint where the two pieces of track meet.



Steps for installing the gate wheels in the frame.

RG-20 2 template kit for wheel installation



① Using the template, mark the area to cut and drill.

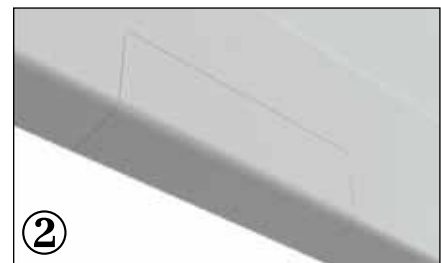

② The gate frame section is marked and ready to be cut.



③ Cut and drill the gate frame section.



④ The drive wheel is recessed into the cutout.